

See discussions, stats, and author profiles for this publication at: <https://www.researchgate.net/publication/337544962>

# A Retail Agro-Vet Application System: A Case of a Kenyan Agro-Vet

Article · November 2019

CITATIONS

0

READS

1,787

3 authors:



**Gibson Kimutai**  
Moi University

4 PUBLICATIONS 0 CITATIONS

[SEE PROFILE](#)



**Alexander Ngenzi**  
University of Rwanda

13 PUBLICATIONS 31 CITATIONS

[SEE PROFILE](#)



**Ambrose Kiprop**  
Moi University

32 PUBLICATIONS 165 CITATIONS

[SEE PROFILE](#)

Some of the authors of this publication are also working on these related projects:



Natural products as additives in formulation of drilling mud [View project](#)



The speciation of trace metals and equilibrium chemistry of hydrological systems [View project](#)



# **A Retail Agro-Vet Application System: A Case of a Kenyan Agro-Vet**

**Gibson Kimutai<sup>1,4</sup>; Alexander Ngenzi<sup>2</sup>; Ambrose Kiprop<sup>3,4,5</sup>**

<sup>1</sup>Department of statistics and Computer Science, Moi University, Kenya

<sup>2</sup>Department of Computer and Software Engineering, University of Rwanda

<sup>3</sup>Department of Chemistry, Moi University, Kenya

<sup>4</sup>A Sustainable Approach to Livelihood Improvement (ASALI)

<sup>5</sup>African Center of Excellence in Phytochemicals, Textile and Renewable Energy (ACE II-PTRE)

Corresponding Email: [kimutaigibs@gmail.com](mailto:kimutaigibs@gmail.com)

---

*Abstract— Modern hand held devices such as smart phones and Personal Digital Assistant (PDAs) have become increasingly powerful in the recent years. Dramatic breakthroughs in processing power which has evolved over time along with the number of extra features included in these devices have opened doors to a wide range of commercial possibilities. The incorporation of android and iPhone Operating System (IOS) have built a new dimensional view of mobile phones incorporating applications to be designed and run on them. As mobile devices become more like Personal Computers( PC's), they will come to replace objects we tend to carry around such as checkbooks , credit cards , cameras, planners , mp3 players etc. In short we will be using them to accomplish our daily tasks with greater efficiency and simplicity. One application that falls in this category is the 'My Business' Application for android smart phones. My Business Application is focused on Agro-Vetinary (AgroVet) retail business with prime objective of managing and maintaining the daily operations of the business. It includes calculation of profits and maintenance of records such as receipts for purchases and finally giving advice to the customer on the current market demand and aid in the preparation of the Business budget. The application will both be used by the business owner for administrative functions as well as being able to assign to his or her employees to manage the transactions of the business.*

*Keywords—Mobile devices, Android application, Agro-Vet, system*

---

## **I. INTRODUCTION**

AgroVet business is a sole proprietorship or can be a partnership business dealing with Agro-vetinary products and services[1]. The products include: farm inputs, insecticides, seeds for planting, animal feeds whereas the services offered includes artificial insemination and others.

The AgroVet Business app is a management android application that will be used by the owner of the business and, or agro-vet attendant (employee) to automate the running of the business. All the operation of the business from purchases of the AgroVet products entries and their stock and all the relevant records or details to be considered to keeping entries of the sales made: the date of sale, product, selling price and then calculates the profit on daily, weekly or monthly basis. The application in a period of time will be able to notify the user on the stock levels or the products running out of stock and as well enable the user to make the business budget. As a

comprehensive application the Agrovet business app will also take into account the expenditure incurred in running the business such electricity, rent, labour and miscellaneous and enable one to manage customer debts.

#### *A. Problem statement*

Currently most of the retail AgroVet businesses run their business on manual basis[2]. This methodology has several limitations than its cons of which at advance levels this has led to failure and closure of most agrovet businesses. Some of these problems include: The manual record keeping is unreliable as most of the important records such as receipts get lost, Poor analysis of the market and their demand levels. This has led to an Agro vet owner purchasing goods that will stay long in the store, Poor management of the daily operations where one does not quite know the amount of sales made this leads to improper usage of money.

#### *B. Current System*

Currently Bondeni Agrovet implements a manual system in its operation where after purchases from supplier receipts are stored for future use when going to make other purchase.

Price tags for each product is written down in a sheet though this is a good method for references its sometimes cumbersome when there a lot of good or items are in stock as searching an entry could take time to get making it inefficient.

On a weekly basis the owner takes time to check through all the items in the store taking a count on which are running out of stock so as to go make other purchases. This manual process has been very tedious.

Customer credits are written down in a book named “Madeni” indicating the name, product taken and the total amount owed. This enables the owner to keep their record and set dates for the debtors to pay back. Due to that this records are kept on daily basis and on cases where a customer who last took goods on credit takes good on credit his or her new record will certainly be on another page this has posed a problem of accuracy as when totaling up the individual amount the owner might forget another page of records as well as it consumes time to add this total owed.

#### *C. Objective of the study*

The objectives of this study was to develop a system that is efficient in operation and that will lead to proper management of the agrovet businesses.

#### *D. Justification*

It's through proper records in databases that data mining is performed to establish the performance of entire business. Through comparison of business performance at different period the owner is able to tell where the business is coming from, and be able to plan the future.

- Creating database would enhance easy updating of small business records.
- The system enhances accurate and fast business transactions
- The database created would be protected by password to avoid any alteration.

#### *E. Functional requirements*

This specifies intended system performance and behavior[3]. It helps outlines the functions of the proposed system stated as follows: Enable entries of purchases made, Entries of sales made during a business operation day, Calculations of profits or losses made by the business, giving notification of low stock levels, recording expenditure incurred by the business in a given period of time and making of business budget.

#### *F. Non-functional requirements*

Non-functional requirements address aspects of the system other than the specific functions it performs [3]. Systems must exhibit software quality attributes, such as: to enable secure record keeping, availability, reliability, recoverability, maintainability, security, data Integrity, usability and interoperability [3].

## **II. LITERATURE REVIEW**

This section gives a view of the selected existing knowledge from literature on inventory management as put across by different authors. It gives theories and hypothesis methods and methodologies relevant to the study area

#### *A. Conceptual Framework*

A mobile application is a computer program designed to run on smartphones, tablet computers and other mobile devices[4]. Applications are usually available through application distribution platform, which began appearing in 2008 and are typically operated by the owner of the mobile operating system, such as the Apple App Store, Google Play, Windows Phone Store, and BlackBerry App World[4].

Mobile apps were originally offered for general productivity and information retrieval, including email, calendar, contacts, stock market and weather information. However, public demand and the availability of developer tools drove rapid expansion into other categories, such as those handled by desktop application software packages. As with other software, the explosion in number and variety of apps made discovery a challenge, which in turn led to the creation of a wide range of review, recommendation, and curation sources, including blogs, magazines, and dedicated online app-discovery services. In 2014 government regulatory agencies began trying to regulate and curate apps, particularly medical apps [5].

The popularity of mobile apps has continued to rise, as their usage has become increasingly prevalent across mobile phone users. A May 2012 comScore study reported that during the previous quarter, more mobile subscribers used apps than browsed the web on their devices: 51.1% vs. 49.8% respectively. Researchers found that usage of mobile apps strongly correlates with user context and depends on user's location and time of the day[6].

The Agrovet business is a retail business that fall under pharmaceutical category of business [1]. There are approximately 9000 major Agro-Vetinary retail business in Kenya with a high expectation growth of 30% in the next two years. Most of which use manual record keeping process while other improved Agro-Vets have improved to purchase computer application programs for use in running their day to day business transactions[7].

### B. *The Economic Order Quantity Concept*

The Economic Order Quantity Concept (EOQ) is the number of units that a company should add to stock with each order to minimize the total costs of inventory such as holding cost and order costs [8]. The economic order quantity (EOQ) attempts to reconcile the problem of how much inventory should be added when inventory is replenished. If the firm is buying raw material, it has to decide lots in which it has to be purchased on each replenishment shortage ordering costs[9] EOQ is common in manufacturing companies where the ordering of stock is constant and repetitive. It is primarily used for purchase-to-stock distribution and makes purchase-to-stock manufacturers. These are businesses that have multiple orders, release dates for their products and have to plan their components[8].

### C. Case Study

Bhakta Bahadur Saud, a resident of Kuldevmandu VDC of Bajura District, who earns his living by selling agricultural inputs to local farmers which he buy from the agro-vets of other districts made recommendation that an agricultural pharmaceutical business can be ran and managed well if there could be a computer system to manage the business operation , monitor the business progress, give advice on the market changes on demand as well as taking advantage of rapid changes in technological implementation [10]. Upon his recommendation he aided in the development of such a system which serve best on a large scale retail. Bhankta Bahandhur system published in 2010 mainly is a windows based system that manages all the operation of a wholesale Agro vetinary business. The application is categorized into the following modules: Point of sales, Stock Management and Supply chain. However the following are our observations as the weaknesses of the system: The system has no proper way or does not gather for market analysis of the goods which are on high demand and those of which that have stayed in the stock for a long period of time this hence therefore does not enable the user or the owner of a business to make decision on which goods to purchase more and which not to purchase[10]. Expiry date notifications- the system does not register the expiry dates of the products purchased hence in the long run goods might expire without the owner knowing. A best system could be giving notifications prior to the expiry date. The system required the owner to purchase a computer, barcode reader and printer which is expensive compared to having a phone and a supporting printer to perform the activities of an Agro vet system[10].

ACME Group is one of the leading and diversified global conglomerates in Bangladesh, with offices in all major cities, employing over 3000+ employees and dedicated to bringing the highest quality products and services to the customers. They have an annual turnover of US \$60 million with diversified interests in Pharmaceuticals, FMCG, Information Technology Services, Aviation Services, Printing & Packaging Services, Trading Services, C & F Services, Apparels and more [11].The conglomerate has an outstanding record of all around excellence and growth in the relevant business activities. Like a Captain in the Ship, ACME Leads the Bangladeshi local industries since 1954. Starting from Pharmaceuticals business ACME is now managing more than 12 SBO. In the path of glory ACME starts FMCG business in 2005, named as ACME Agrovet & Beverages Ltd. Now ACME has 9 different products items in its product basket. From Collection of "Raw material" to selection of "Packing material" everywhere ACME keeps its commitment to the nation. ACME carefully select the entire members perform inbound logistics to outbound logistics. ACME select distributor as there distribution partners, ACME maintain some criteria to select them. Sales forces of ACME are the real star of the organization. The actually provide the sales revenue for the organization. As ACME do not perform sufficient ATL activities so sales force has to do lot of activities[11].

VetHelp Agrovet Market is a Spanish language based indispensable tool specially designed for veterinarians and animal health professional, provides a quick and easy reference of pharmacological active, values and physiological constants, specific calculators for veterinary practice, among many other features. Download VetHelp AM to access: • Form of nearly 600 active ingredients for veterinary medicine • More than 6,000 interactions between active • Constants physiological and clinical values for 11 animal species • 13 scientific calculators and veterinary (conversions, dosage, animal age, pregnancy, transfusion, hydration, etc.) • Complete Handbook on Agrovet Market Animal Health Keywords: Vethelp, agrovet market, veterinarian, animal health, pharmacology, veterinary medicine, animal production.

Sunshine Agrovet operates as an integrated supply chain manager offering supply chain solutions, from the farm gate/production center in India to our customers’ destination markets. Implemented an Agrovet system that strives to manage each activity in the supply chain from origination to processing, logistics, marketing and distribution. The complete integration allows Sunshine Agrovet to control their supply chain, achieve operational efficiencies, add value and manage the various risks along the entire supply chain, enabling them to therefore appropriate the margins which exist in each part of the supply chain. The system is aimed at providing utmost transparency in business, adopt to execute any export order, minimize the incurring cost and maximize the asset value. From the system the Customers can request their order and our business people will be at their disposal for easy shipment and delivery. The system as well enables them to schedule the delivery of their products to their customers who are within the whole country or internationally. Our distinctive position is based on the strength of our origination capability and the customized marketing solutions we provide to our customers.

### III.METHODOLOGY

#### A. Software development methodology

A software development methodology or system development methodology is a framework that is used to structure, plan, and control the process of developing an information system[12]. While developing the Agrovet application Waterfall software development model was implemented. The waterfall model is a sequential design process, often used in software development processes, in which progress is seen as flowing steadily downwards (like a waterfall) through the phases of Conception, Initiation, Analysis, Design, Construction, Testing, Production/Implementation, and Maintenance[12]. It advocates for systematic sequential approach that begins with a detailed fact finding process. The following is a diagrammatic representation of different phases of waterfall model.

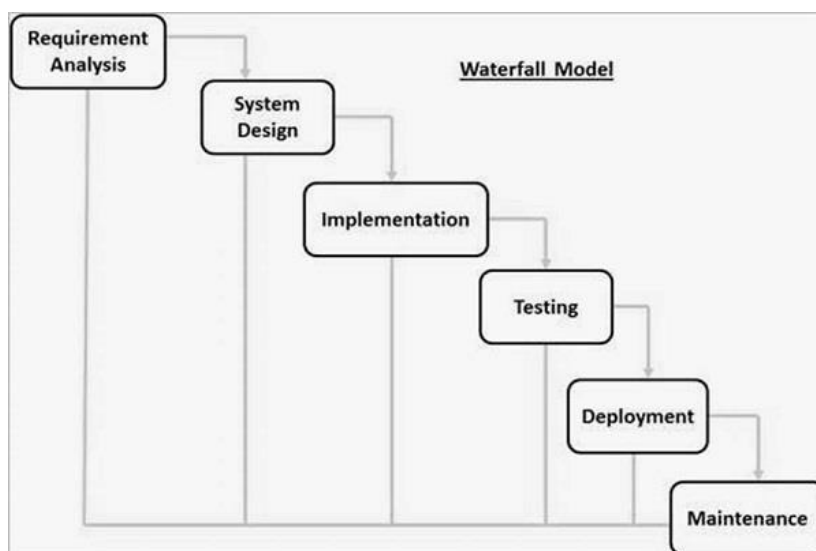

Fig. 1:Waterfall Model[3]

#### B. System Design.

The requirement specifications from first phase were studied in this phase and system design prepared[3]. System Design helped in specifying hardware and system requirements and also helped in defining overall system architecture[3].

*i. System Coding and Testing:*

The system specifications are turned into a working system by writing, testing and, documentation of the entire process[12]. Visual basic has been used in coding the proposed system. Unit testing and entire system testing are performed to confirm customer satisfaction.

*ii. 3.1.5 Development tools.*

XML used in creating views or user interface elements like buttons, listviews, datagrids, and textfields. These are part of the graphical user interface. They help to create a user friendly interface that is both easy to use and easy to learn. Java is used to execute operations or events according to the triggers from views. It is used to develop android activities that respond to users' activities or input. It is also used to create the link between the user interface and the server. Backend-SQLite Server was used as a database server where databases and tables are created as well as storing their contents. Eclipse IDE provides tools to develop debug and test android applications as well as deploying and signing digital certificates. SDK- Android SDK which is an Android tool kit containing emulators and components to develop apps that port on android platform regardless of the device to run compatibly was used.

*iii. Hardware Requirements Tools*

Pentium iv processor ,250GB hard disk, 2GB RAM, Storage device like flash disk, Keyboard, mouse and monitor, Printer and Android phone.

*C. Requirement Gathering and analysis*

This encompasses those tasks that go into determining the needs or conditions to meet for a new or altered product or project, taking account of the possibly conflicting requirements of the various stakeholders, analyzing, documenting, validating and managing software or system requirements. The following methods were used in information gathering:

*i. Interviews:*

Interview is the process of obtaining information from a person through asking of questions and getting feedback or response[13]. It involves two categories of people: the interviewer and the interviewee[13]. The interviewer asks the questions while the interviewee gives the response.

*ii. Observation:*

Information was gathered through actively participating in the daily activities of the Bondeni Agro vet by watching and listening, this was relevant as it helped in determining the rate of customer arrival and efficiency in services rendered.

*D. System Design*

Data flow diagram has been used to represent how data is captured, processed, stored and distributed within a system[3].They demonstrate the information and how it flows between specific processes in a system. These diagrams help to show how data moves and changes through the system in a graphical top-down fashion.

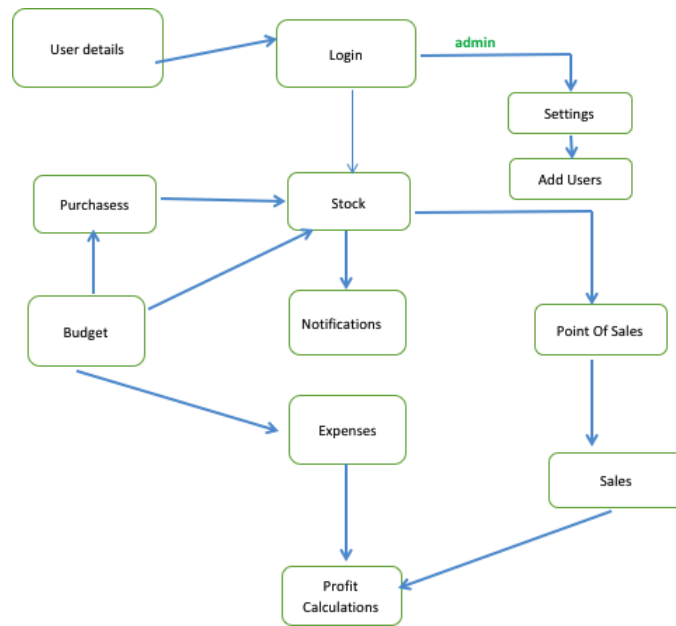

Fig. 1 Data Flow Diagram

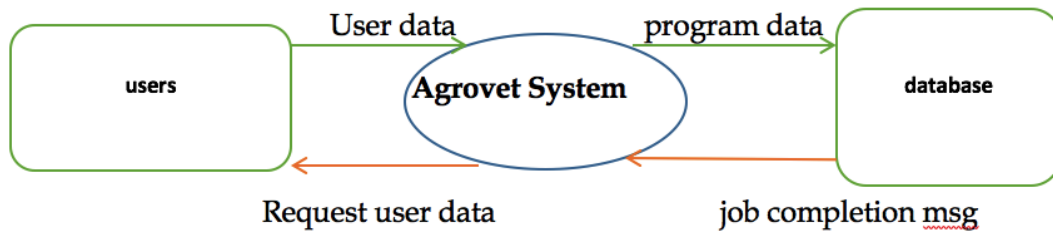

Fig. 2: Context Diagram

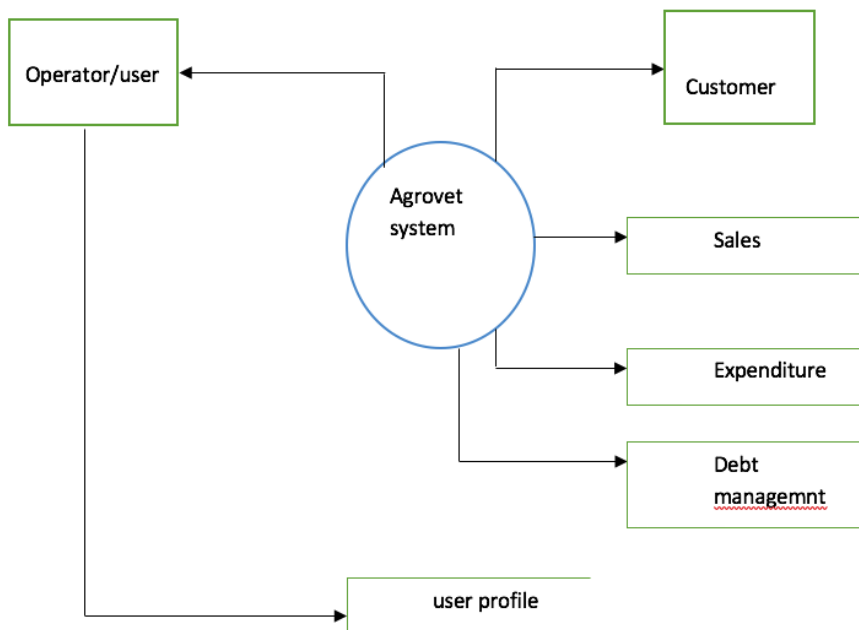

Fig.3: Context Level Diagram

**E. Interface Design**

All the interface forms that was used in the system to solicit the user to enter data in to the program are shown here. Also any dialogue interface forms is drawn here. They are used to display message to the user to allow good communication of the user and the system.

1. The entries to the system start from the user login- where only the intended user accesses the system functionality and keeps out unregistered or authorized users.

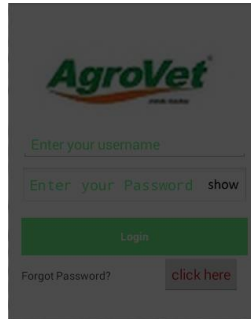

Fig. 4: Login Page

2. Purchases

This entails the user entering primary good as purchases or to be added into the business

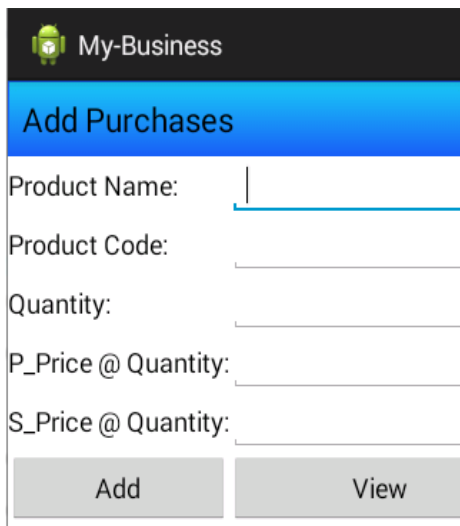

Fig.5: Point of sales

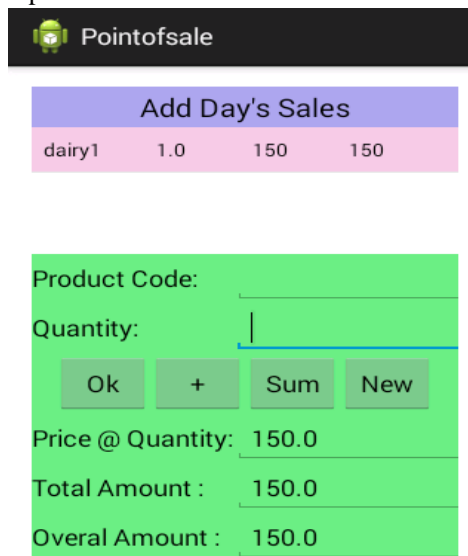

Fig.6 : Add Purchases

3. Sales/Point of sales
4. This is where the sales made at a particular time are entered into the system
5. This is displayed as above in figure 6
6. Expenses
7. This is where the user enters the expenses incurred during the operation of the system as is displayed in fig. 8 and 9



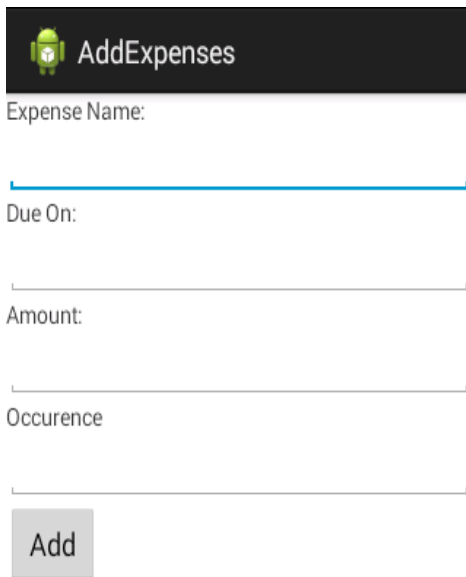

Fig. 8 : Add Expenses



Fig. 9: Display Purchases

#### F. Process Design

This display the process flow of information from the various activities in the program units this are consolidated into flowcharts and UML diagrams

##### i. Unified Modeling Language (UML):

The Unified Modeling Language (UML) is a general-purpose modeling language designed to provide a standard way to visualize the design of a system[3].

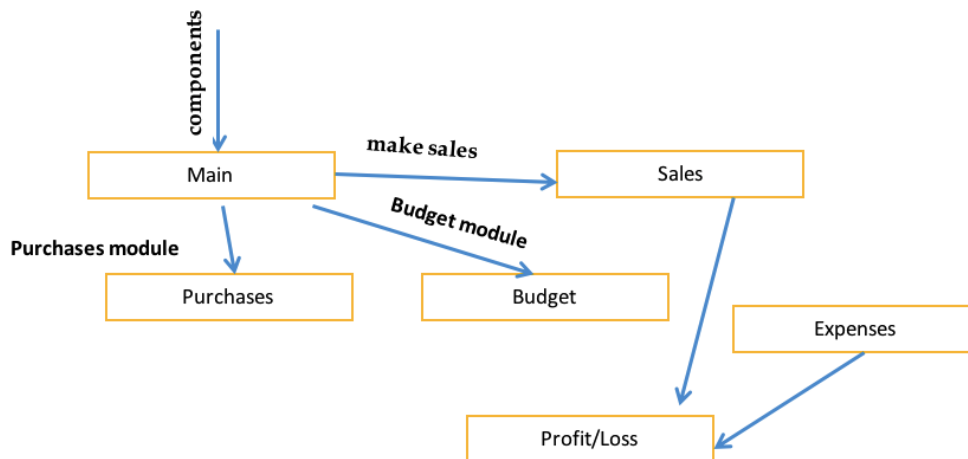

Fig. 10: Component UML

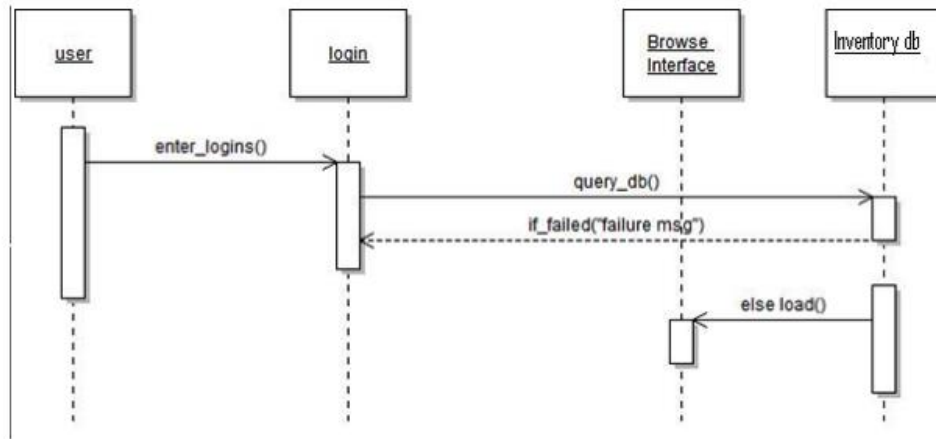

Fig. 11: Sequence Diagram

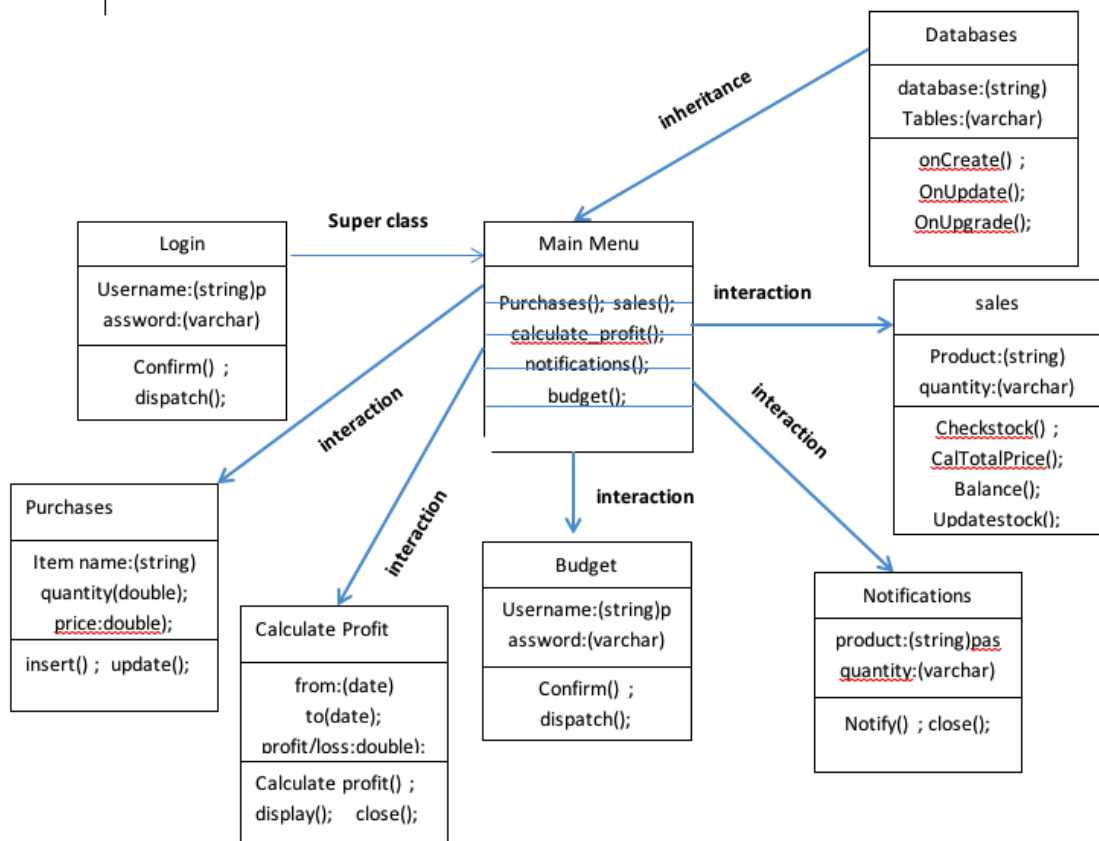

Fig. 11: Structural Diagram

#### IV. CONCLUSIONS

In this paper, an android application system for use in an Agro-Vet has been developed. As a comprehensive application the Agro vet business app will also take into account the expenditure incurred in running the business such electricity, rent, labor and miscellaneous and enable one to manage customer debts. In future, we intend to develop a corresponding system that can work in IOS. We also endeavor to develop a web application of the system.

#### ACKNOWLEDGEMENT

The authors wish to acknowledge Bondeni Agro-vet management for the hospitality, constructive comments and useful advices throughout the development of the system, testing and its eventual deployment. The first author wishes to put on record sincere appreciation to the third author for the mentorship and seamless introduction into the academic world.

## REFERENCES

- [1] M. Singh and K. L. Maharjan, "Crop Production and Net Return from Organic and Conventional Farming Systems," in *Sustainability of Organic Farming in Nepal*, Singapore: Springer Singapore, 2017, pp. 133–149.
- [2] G. Rintaugu, "The Challenges faced by Small Scale Family businesses in Africa: Evidence from Kenya.," 2013.
- [3] I. Sommerville, *Software engineering*. Pearson, 2016.
- [4] K. Holl and F. Elberzhager, "Mobile Application Quality Assurance," *Adv. Comput.*, vol. 112, pp. 1–77, Jan. 2019.
- [5] S. K. Jain, A. Jain, A. Goswami, R. Purohit, A. S. Hari Haran Vinjarapu, and S. Kumar Gawre, "IoT based Smart Tea leaves Plucker with Two Revolute type Planar Manipulator," in *2018 IEEE International Students' Conference on Electrical, Electronics and Computer Science (SCEECS)*, 2018, pp. 1–6.
- [6] G. Gupta and N. Vaid, "The World of Orthodontic apps.," *APOS Trends Orthod.*, vol. 7, no. 2, p. 73, 2017.
- [7] C. Rademaker, B. Bebe, J. van der Lee, C. Kilelu, and C. Tonui, "Sustainable growth of the Kenyan dairy sector A quick scan of robustness, reliability and resilience." 2016.
- [8] F. Mwaura and O. Muku, "Tea Farming Enterprise Contribution to Smallholders' Well Being In Kenya," 2007 Second Int. Conf. August 20-22, 2007, Accra, Ghana, 2008.
- [9] E. K. Kagira, S. W. Kimani, and K. S. Githii, "Sustainable Methods of Addressing Challenges Facing Small Holder Tea Sector in Kenya: A Supply Chain Management Approach," *J. Manag. Sustain.*, vol. 2, no. 2, May 2012.
- [10] "Ministry of Agriculture Food and Agriculture and Cooperatives (MOAC) Organization of the United Nations District Disaster Risk Management Plan Kapilvastu District," 2011.
- [11] "Acme Is A Large Pharmaceutical Company Information Technology Essay." [Online]. Available: <https://www.ukessays.com/essays/information-technology/acme-is-a-large-pharmaceutical-company-information-technology-essay.php>. [Accessed: 18-Mar-2019].
- [12] J. Dooley, *Software development, design and coding: with patterns, debugging, unit testing, and refactoring*. .
- [13] R. Kumar, *Research methodology : a step-by-step guide for beginners*.